

12 660 979













Passt zu: IMO, LULU, MADISON, MEM, TARA, CL.1, LISSÉ, VAIA, META, CYO

- Abdeckplatte 150 x 240 x 15 mm
- WC-Armatur mit Drehbetätigung und Zwei-Mengen-Technik (Vollspülung/Teilspülung)

Dieses Produkt ist kompatibel mit den nachfolgenden Produkten der Firma TECE:

- TECEprofil Trockenbau, Artikelnummern:
9300300, 9300322, 9300301, 9300344, 9300309, 9300303, 9300388, 9300366, 9300102, 9300103
- TECEbox Nassbau, Artikelnummern:
9370300, 9375300, 9371300

	Chrom gebürstet	12 660 979-93
	Chrom	12 660 979-00
	Platin gebürstet	12 660 979-06
	Platin	12 660 979-08
	Dark Chrome	12 660 979-19
	Light Gold	12 660 979-26
	Light Gold gebürstet	12 660 979-27
	Messing gebürstet (23kt Gold)	12 660 979-28
	Schwarz matt	12 660 979-33
	Bronze gebürstet	12 660 979-42
	Champagne gebürstet (22kt Gold)	12 660 979-46
	Champagne (22kt Gold)	12 660 979-47
	Dark Platinum gebürstet	12 660 979-99

12 660 979

mm [inches]



12 660 979

Ersatzteile für die
anderen
Oberflächenvarianten
finden Sie hier:
Chrom

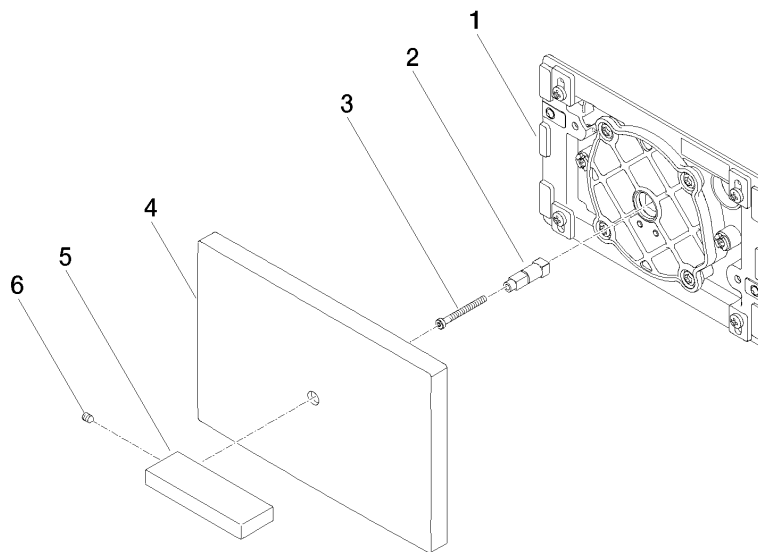

Ersatzteilstückliste

Nr.	Artikelnummer	Benennung	Verbaumenge	Lieferzeit
1	04 28 01 053 00 90	Platte	1	2
2	09 18 20 038 90	Aufnahme	1	2
3	09 30 30 086 90	Schraube	1	2
4	09 11 01 179-93	Abdeckung	1	-
Ersatzteil nicht mehr bestellbar, bitte bestellen Sie den Nachfolgeartikel				
5	09 20 97 057-93	Griff	1	20
6	09 31 11 058 90	Stift	1	2